

USER MANUAL

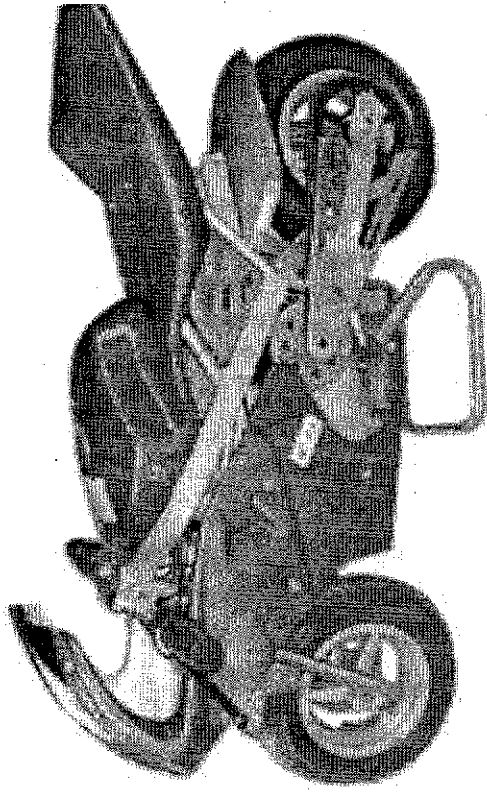

Contents

Warning	2
Specifications	3
Main parts description	4
User manual	5
Inflating the tires	5
Regarding the POCKET MOTORCYCLE rear wheel	5
The brake	6
Handlebar installation	7
Circuit diagram	8

Circuit diagram

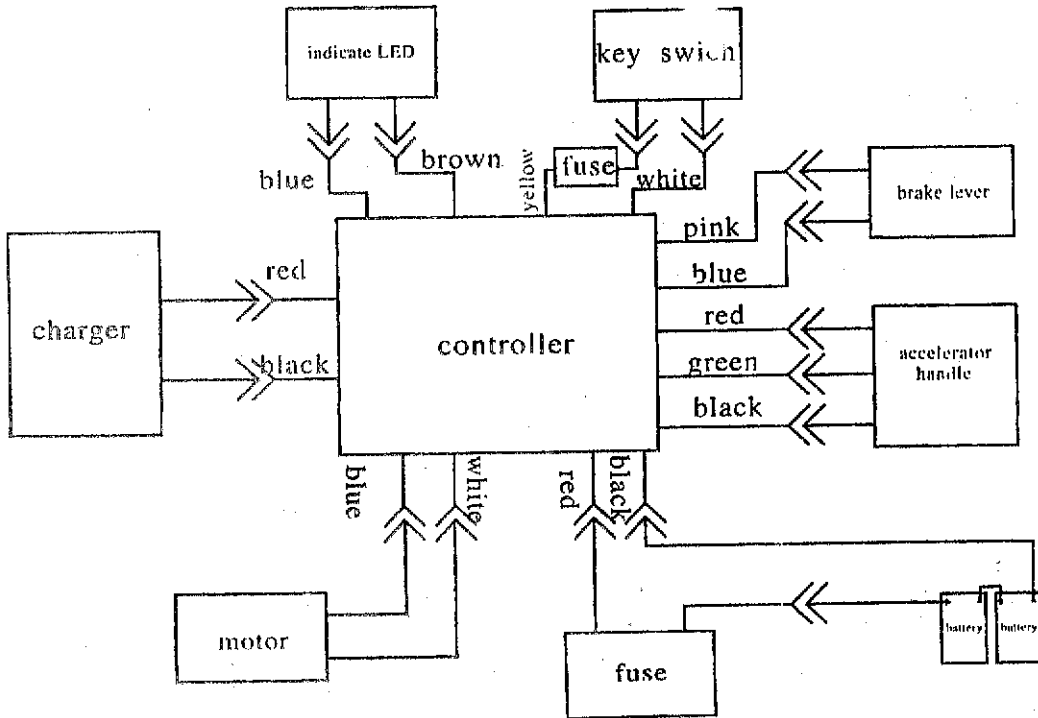

HOW TO USE THE POCKET MOTORCYCLE

WARNING!!!

1. Do not charge it for over 18 hours. Otherwise, the battery will be damaged and the longevity decreased.
2. Six hours for charging are usually enough, but two to three hours are more than enough to enhance the battery power.
3. The scooter must be charged once in every 10 days even if it is not in use.
4. Do not go uphill or suddenly thrust the accelerator quickly (do not abuse the product).
5. Do not ride the scooter if you are under sixteen years old.
6. Always equip a helmet & safety gears before riding.
7. You can't ride the scooter if you are over 200 pounds.
8. Always check the brake and accelerator before using scooter
9. The battery can only take between 300 to 330 times charges before replacing it with a new one.
10. Do not put the water for wash & ride it in raining day.

Welcome to using our pocket motorcycle!

Handlebar installation:



(fig 4)



(fig 5)

Loosen the Hex bolt using the 5mm small Hex wrench, make the handle reach regulating proper position (fig 5), adjust and tighten the screw well.

Warn! Must check after tightening the screw whether the handle can become flexible (holding the front fork in one hand, holding the handle in another hand and see whether it is rotated or not rotated).

The brake

Your scooter is fitted with a hand-operated brake (Figure3). To use the brake, squeeze the lever to increase the pressure of the brake until you come to a smooth and controlled stop. Rotate the cable adjuster to adjust the brake. Place until it reach a good (about 1/4 to 1/2 of all raelian).

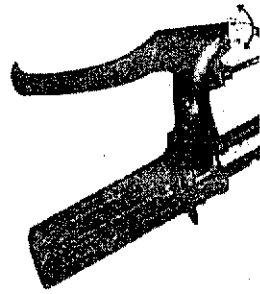

(fig 3)

Foot rod installation :

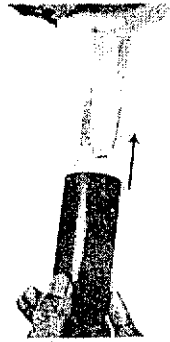

(fig 6)

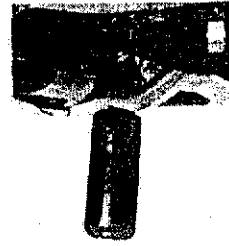

(fig 7)

SPECIFICATION

ITEM	DESCRIPTION
Carton size (L*W*H)	108 x 36 x 65(cm)
Dimension (L*W*H)	105 x 50 x 60 (cm)
Net weight	25kg
Tire	11IN
Control system	PWM
Motor	PC36V/500W
Battery	3*12V*12ah
Charger	AC110/220V , dc24v/1.8A
Top speed	28km/hr
Max loading capacity	75kg
The largest	±25°
Running duration	20km
Charger time	5-6hr
Cover	FRP
Brake way	Front & rear Disc Brake

Main parts description

(see fig 1)

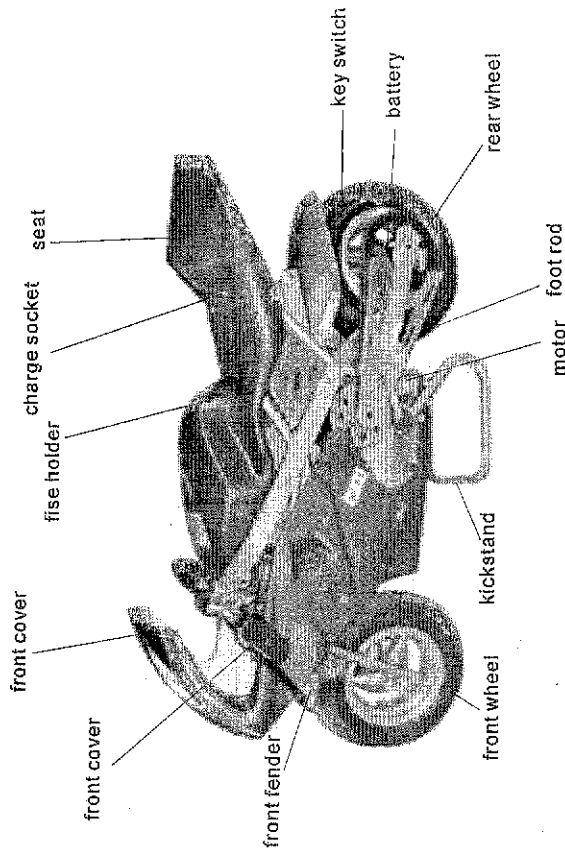

(fig 1)

Inflating the tires

The tires are inflated when shipped, but they invariably will lose some pressure between the point of manufacturing and your purchase.

Using a tire pump with a Schrader-type valve, to inflate the tires to 35-40 PSI, or as indicated on the sidewall of the tire.

Regarding the POCKET MOTORCYCLE rear wheel:

Inflating the rear tire of the POCKET MOTORCYCLE requires the use of a special valve extender, the valve should be inserted into the access hole of the sprockets when you want to inflate rear tire. (See fig2)

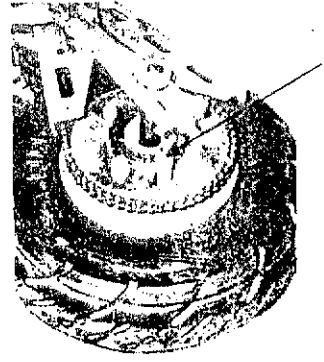

(fig 2)